

AUSTUR

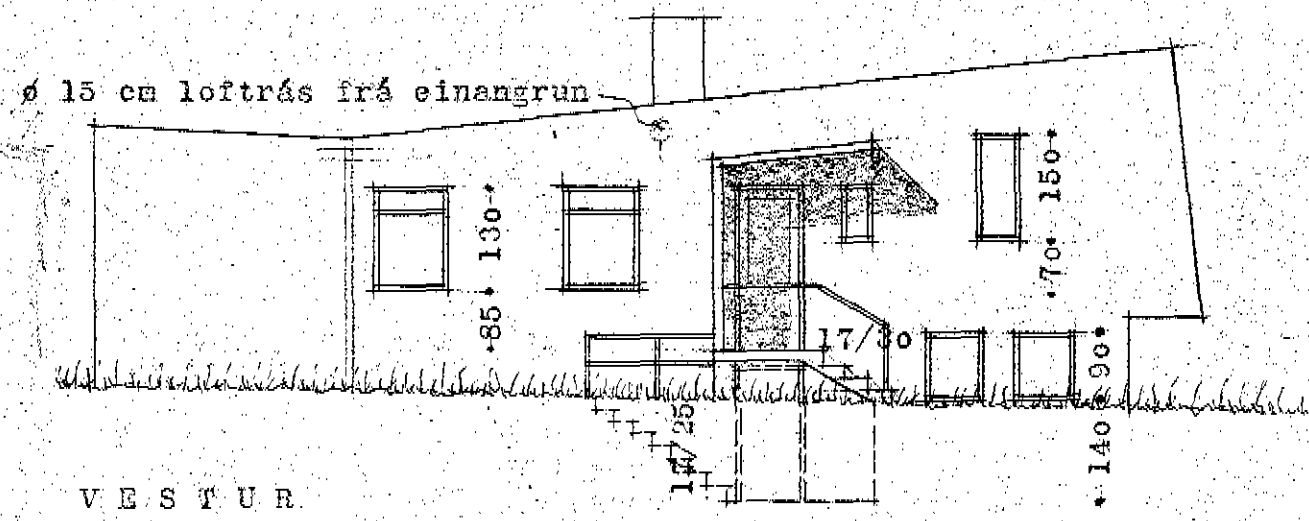

VESTUR

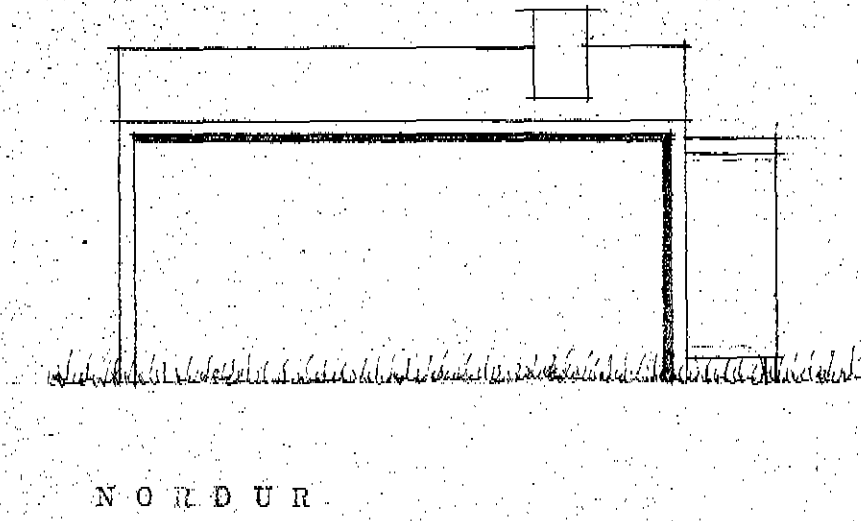

NORDUR

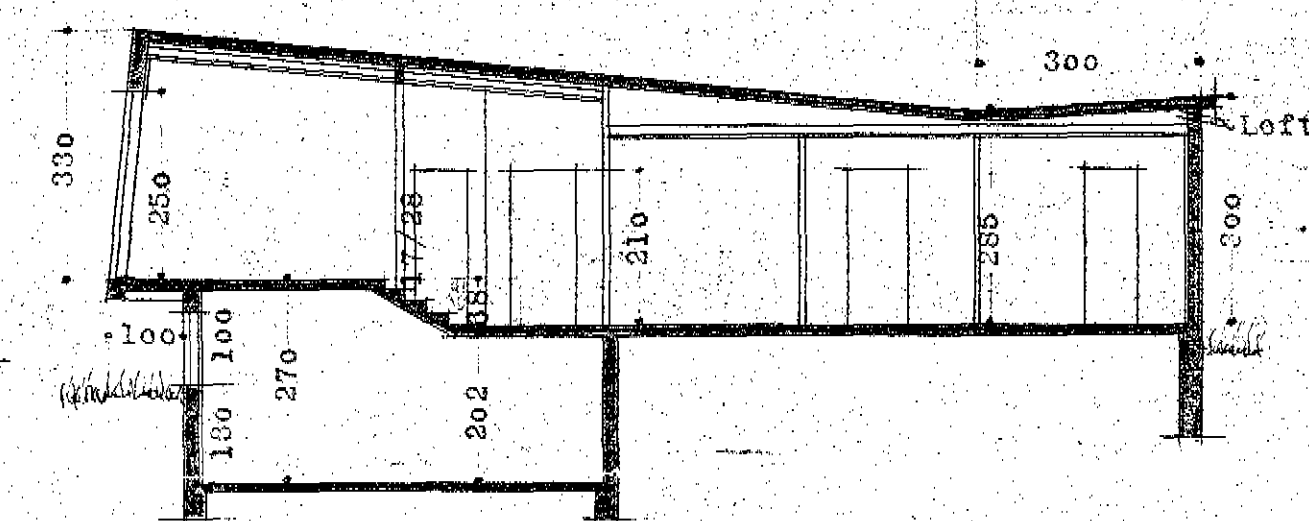

SUDUR

SKURÐUR

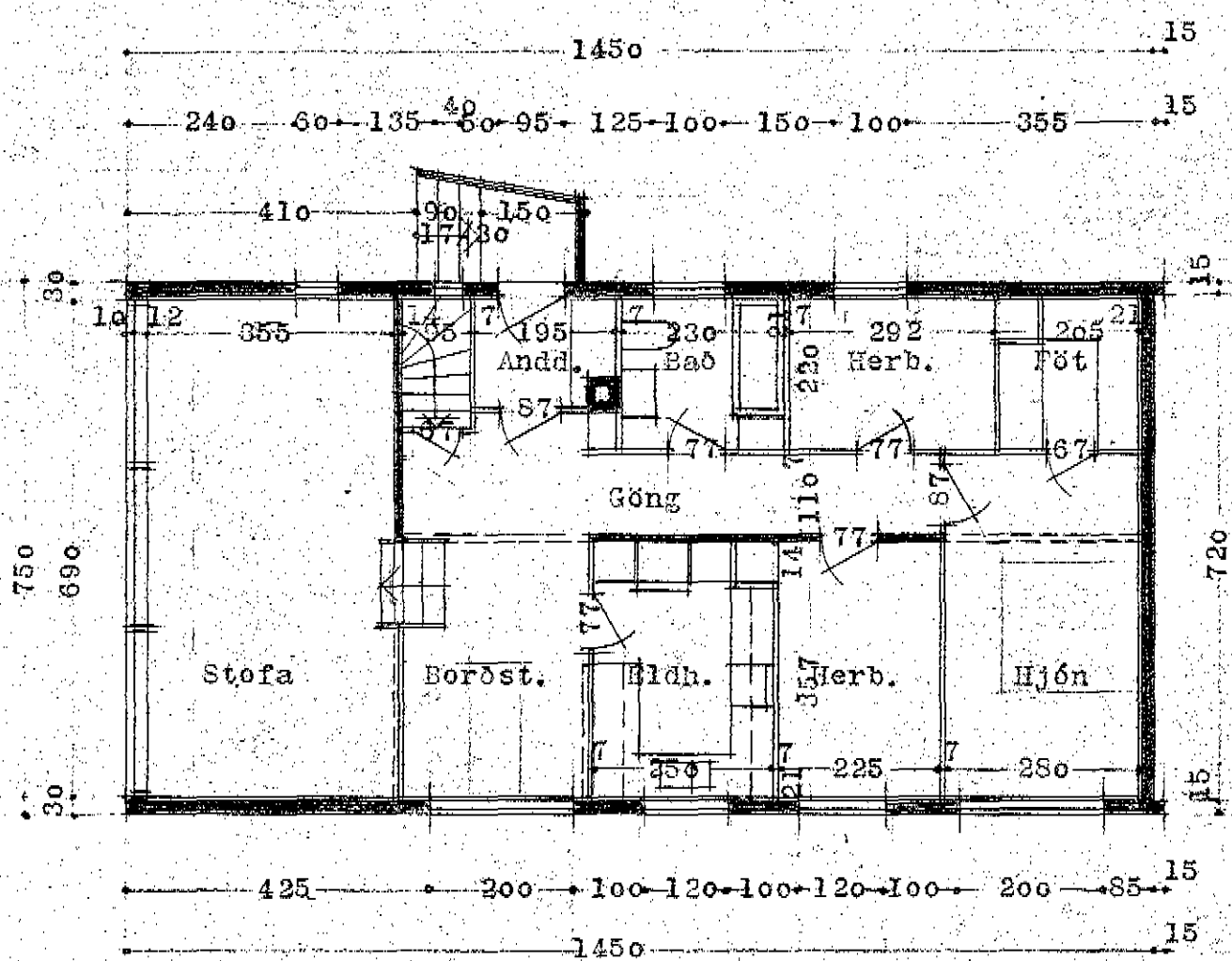

GRUNNMYND 1. HÆÐAR

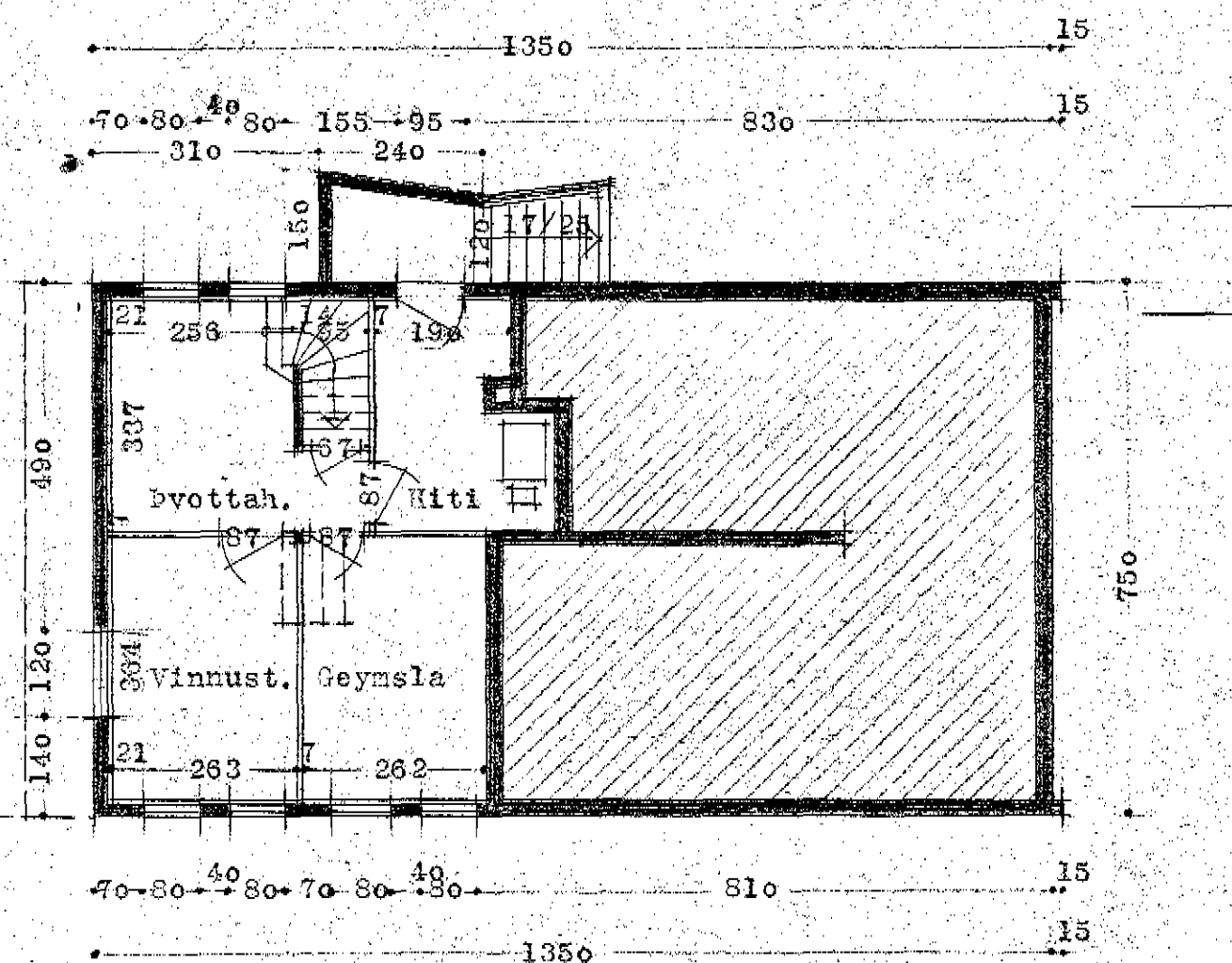

TJALLARI

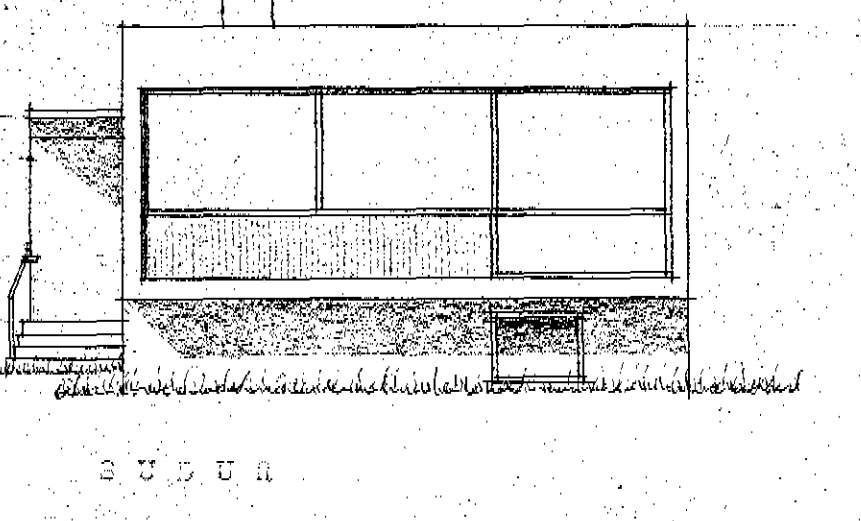

SUDUR

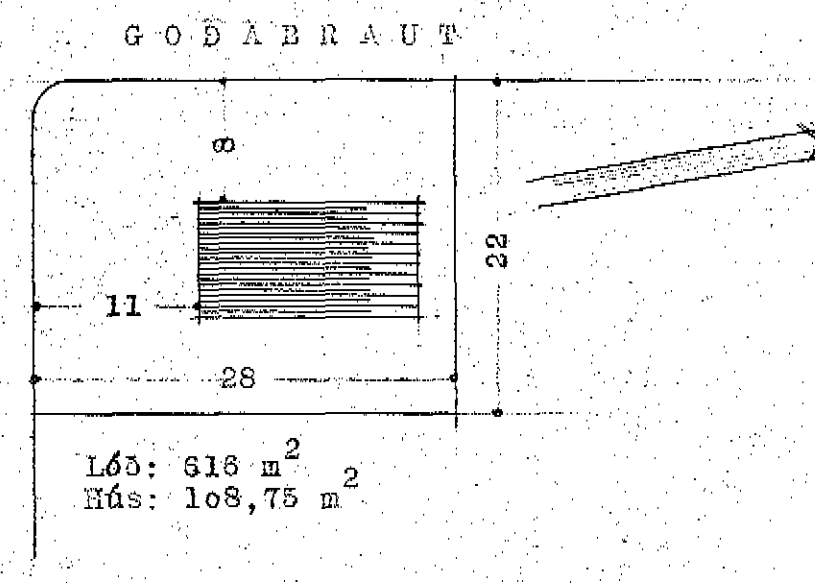

AFSTÖÐUMYND 1:500

$E = 440,6 m^2$
 GODABRAUT 19